

FLUORESCENCE BASED OPTICAL FIBER SENSOR FOR DISSOLVED OXYGEN DETECTION IN WATER MEDIA

Fátima C. de Oliveira¹, Mauro S. Braga², Guilherme M. Gonçalves³, Walter J. Salcedo⁴

Abstract — We proposed the fluorescence based optical fiber sensor for dissolved oxygen (DO) in water media using the integrated circuit photodiodes array as a detector and diode LED as an excitation source. The sensor was fabricated using a multimode optical fiber which at its end exposed tip was deposited a PVC thin film doped with octaethylporphyring of platinum (PtOEP) molecules as a sensitive part of device. The sensor showed a good linear response in the region between 4 to 20 mg/L of DO in water media. The response time to sudden change from 0% to 20% of DO showed to be so fast even though the recovery process was slowly due to slow diffusion process of oxygen from the active film into the water media. The integrated fluorescence based optical fiber sensor together with integrated photodiode array and diode LED could be applied as a depth gauge sensor for in-situ DO detection in river, lake and fountain water.

Index Terms — Dissolved oxygen, Fluorescence based optical fiber sensor, Platinum octaethylporphyrin (PtOEP).

INTRODUCTION

It is well known that the oxygen molecules have been essential compounds for life of any biological system in water media. The oxygen concentration in water is also a good indicator of water quality in river, lake and fountains [1-3]. Many methods are used to measure the oxygen content in these media. The traditional method have collected the water samples from the source and after they have analyzed in lab with conventional instrumentation, these procedure have normally expended a lot time since it involves sample collection, sample preparation and sample analysis with complex equipment [4]. Other devices based in electrochemical process had been proposed, these kind of devices normally consumed oxygen that introduces imprecision in the measurement values, additionally the electrochemical sensor suffer strong electric interference from the internal or external source [5-6]. The new type of sensor device based on fluorescence emission have been

successfully used for oxygen gas detection, these device used the dye fluorescent molecules embedded in polymeric host matrix and the oxygen detection principle is based in the fluorescence quenching effect [7-12]. The fluorescent based sensor depends on the oxygen permeability of host matrix, in this sense many host matrices had been proposed in order to improve the sensor sensitivity [7,12]. The dissolved oxygen (DO) detection in water media is still a challenge of fluorescence based sensor device fabrication. It was reported some devices based in optical fiber, on these devices the dye molecules embedded in polymeric host matrix were coated on the apex surface of fiber optic [13,14] or at the tapered surface [15]. All the proposed fluorescence based optical fiber sensors used a spectrometer for fluorescent signal detection [13-15] making so difficult to use this sensor for *in-situ* measurement for example in river or lake water. In this sense in the present work we report the fluorescence based optical fiber sensor for dissolved oxygen in water media, the proposed sensor use the optoelectronic multispectral photodiode system as sensor detector and a diode laser for dye molecules excitation. This sensor is a portable system that can be used easily on in-situ measurement in any water environment.

EXPERIMENTAL PROCEDURE

Optical fiber sensor fabrication

The fluorescent based optical fiber sensor have been fabricated by using the multimodal fiber optic GH4001-ESKA™ based on the polymethylmetacrilate resin with core diameter of 0.980 mm and refractive index of 1.49. These optical fibers are fabricated by Mitsubishi Rayon Co. Ltd. The sensitive part of sensor was built by using the PVC thin film as a host matrix where the Octaethylporphyring of Platinum (PtOEP) molecules had been embedded. For this purpose, the mixture of 2.2 mg of PtOEP and 100 mg of PVC in 1.5 mL of THF solvent and 218 µL of Bis(2-ethylhexyl) sebacate (DOS) was prepared. In order to obtain

¹ Fátima Cristina de Oliveira, Aluna de Mestrado em Microeletrônica da Engenharia Elétrica da EP-USP – Escola Politécnica da Universidade de São Paulo, Avenida Luciano Gualberto, travessa 3, 931, Engenharia Elétrica, sala C2-62, 05.508-010, São Paulo, SP, Brasil, insight_fatima@yahoo.com.br

² Mauro S. Braga, Aluno de Doutorado em Microeletrônica da Engenharia Elétrica da EP-USP – Escola Politécnica da Universidade de São Paulo, Avenida Luciano Gualberto, travessa 3, 931, Engenharia Elétrica, sala C2-62, 05.508-010, São Paulo, SP, Brasil, msbraga@lme.usp.br

³ Guilherme M. Gonçalves, Aluno de Graduação em Tecnologia em Automação Industrial – Instituto Federal de Ciência e Tecnologia de São Paulo, Rua Maria Cristina, 50, 11533-160, Cubatão, SP, Brasil, guilhermeeee@live.com

⁴ Walter J. Salcedo, Professor Doutor e Livre Docente da Engenharia Elétrica da EP-USP – Escola Politécnica da Universidade de São Paulo, Avenida Luciano Gualberto, travessa 3, 931, Engenharia Elétrica, sala C2-62, 05.508-010, São Paulo, SP, Brasil, w.salcedo@lme.usp.br

a homogenous mixture, the solution was mechanically stirred in ultrasonic bath for 30 minutes so the active thin film was obtained by dipping the optical fiber apex into de solution. The PtOEP-PVC thin film covered completely the surface area of fiber optic core.

Signal acquisition system

The fluorescence emission intensity from PtEOP molecules have been measures with integrated circuit photodetector system (Figure 1). The photodetector system is composed by 64 photodiodes forming a 8x8 matrix array, the diodes array is interconnected to a electronic circuit that transform current signal to frequency, i.e., the out of signal was measured as a frequency values. This system is encapsulated in a monolithic integrated CMOS circuit type TCS3200 and it is fabricated by the AMS Company. The 8x8 photodiode matrix is divided in 4 groups each of them with 4x4 sub-matrices. In the each groups, the photodiodes are connected in parallel by interdigitated layout. The three groups of sub-matrices have RGB filters respectively (16 red filters, 16 green filters and 16 blue filters) and the one group doesn't have filter (16 photodiodes). The photodetector system has only one out so the signal out corresponding to each group of photodiodes with the same filters was selected by binary combination of the two digital enters S2 and S3 in the integrated circuit (Figure 1). The out signal is a square wave (50% duty cycle) such that its frequency is directly proportional to the intensity of incident light on the active surface area of photodetector system. In addition, it is possible to select the frequency region of out signal by binary combination of S0 and S1 enters pins (Figure 1).

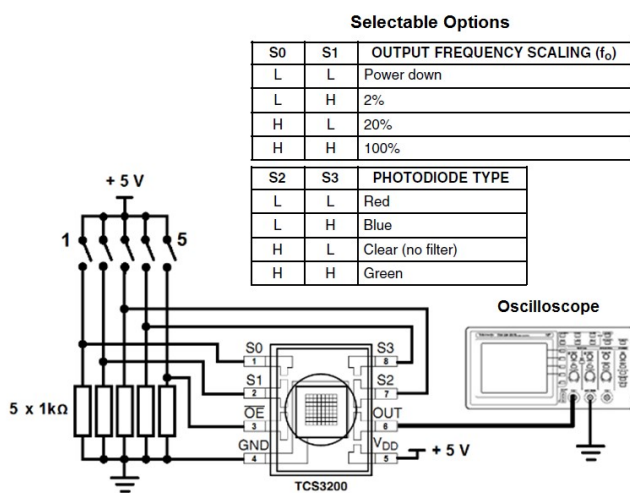

FIGURE. 1

SCHEMATIC DIAGRAM OF PHOTODETECTOR TCS3200 WITH MEASUREMENT SYSTEM.

The sensitive molecules (PtOEP) have been excited with UV-LED diode (1,3 mW, $\lambda = 377$ nm) that it is

fabricated by Lumex Company. The intensity of light emission from diode has been kept constant during measurement process by applying a constant V_{DC} polarization. The Figure 2 depicts schematic diagram of excitation source (LED diode) that excited the one fiber optic apex that it is opposite to sensitive region of fiber optic sensor so in this configuration the optical fiber sensor could be used as depth gauge sensor.

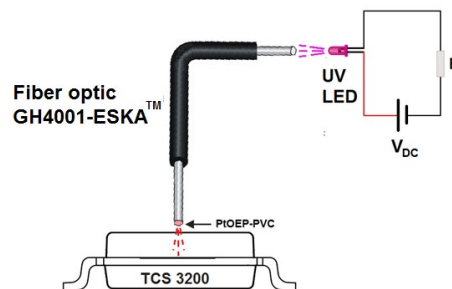

FIGURE. 2

SCHEMATIC DIAGRAM OF OPTICAL FIBER SENSOR EXCITED BY DIODE LED IN ORDER TO EXCITE THE PtOEP MOLECULES AT THE OPPOSITE FIBER TIP AND PHOTODETECTOR TCS3200 THAT DETECT THE FLUORESCENCE EMISSION FROM DYES MOLECULES.

The dissolved oxygen system set-up

In order to obtain a curve calibration of optical fiber sensor response, it was project and built and experimental system that it allows to get a controlled oxygen concentration in water media. For this propose, the deionized water in conical bottle of 250 mL has been bubbled with O_2 and N_2 gases using a metallic bubbler in order to avoid the large bubble in water; this procedure facilitated the water oxygenation or deoxygenation process reducing at maximum the dead time during measurement process. The deionized water pumping with dissolved oxygen was accomplished by Milan mod. 204 peristaltic pump. The Figure 3 depicts the schematic diagram of system used to control de dissolved oxygen concentration in water media.

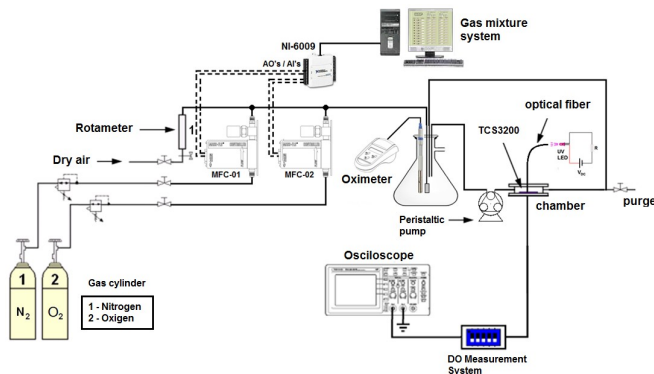

FIGURE. 3

SCHEMATIC DIAGRAM OF SYSTEM USED TO CONTROL THE DO CONCENTRATION IN DEIONIZED WATER.

The dynamics sensor response was accomplished using the same system for DO control used before (Figure 3) adding another conical bottle and directional valve with 5/2 paths. The valve was fired by double solenoid, this set-up enabled to make very fast transition from water without DO in the bottle KT-01 (0 mg/l) to water saturated with DO in bottle KT-02 (20 mg/L). This control was carried out by activation of the S1 and S2 solenoids valves controlled by the application two digital outputs located on the acquisition board. In order to avoid any internal fluctuation in the DO concentration in each bottles (KT-01 and KT-02), a directional control valve 3/2-way, with solenoid drive and spring return was installed at sensor chamber outlet. In the measurement process, the valve S3 was fired always some seconds after S1 or S2 was triggered allowing in this way that any remaining liquid inside the line and the chamber return almost totally to its corresponding bottle enabling to obtain the previous water condition in the sensor chamber. The flow rates of the B01 and B02 peristaltic Pumps are kept equal and constant during the tests. The Figure 4 shows the schematic diagram of the arrangement of the dissolved oxygen control system for dynamic assays and response time of sensor.

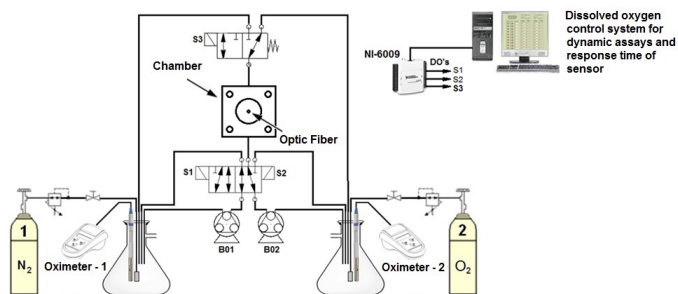

FIGURE. 4

SCHEMATIC DIAGRAM OF DO CONTROL SYSTEM USED FOR DYNAMIC SENSOR RESPONSE ANALYSIS.

RESULTS AND DISCUSSION

The sensor response was defined as the rate of change of frequency output relative to reference frequency that correspond to fluorescence signal from sensor immersed in water without DO:

$$\text{Response} = \frac{\Delta f}{f_{ref}}$$

Where f_{ref} is related to fluorescence intensity from sensor device immersed in water without any DO content.

Since the photodetector is composed by four arrays where three of them have RGB filters and one array without filter, the output corresponding to arrays with RGB filter didn't show any signal when the diode LED excited directly to photodetector so any output signal from the diode arrays with RGB filter must be related to fluorescence emission intensity from the PtOEP molecules. In this way, the photodetector system used in this work only detect the

fluorescence emission from the sensitive part of sensor without any interference with diode LED emission light that is used to excite the dyes molecules.

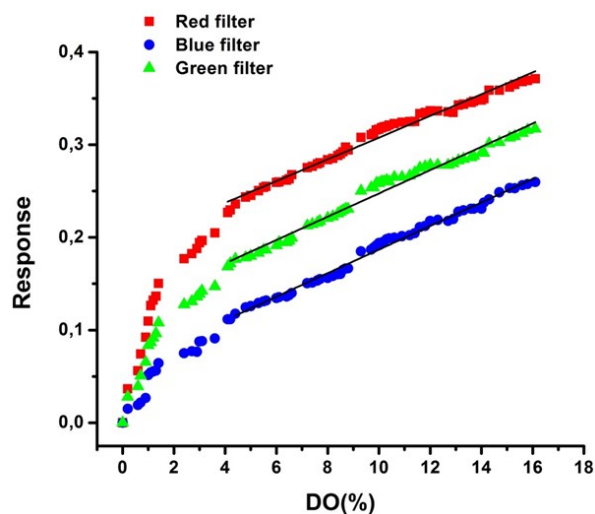

FIGURE. 5

RESPONSE CURVES FROM THE PHOTODIODES ARRAY WITH RED, GREEN AND BLUE FILTER AS A FUNCTION OF DO CONCENTRATION.

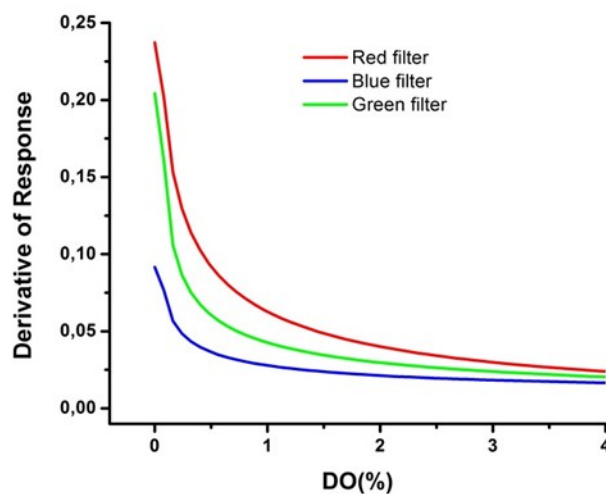

FIGURE. 6

THE DERIVATIVE CURVES OBTAINED FROM THE RESPONSE CURVE IN FIGURE 5 CORRESPONDING TO PHOTODIODES ARRAY WITH RED, GREEN AND BLUE FILTER.

The response curves from red, green and blue fluorescence emission showed the two well defined regions, one region at low DO concentration (0 – 4 mg/L) the response curves showed to be non-linear features and the region corresponding to high DO concentration (from 4 to 20 mg/L) the sensor response showed to have linear behavior for red, green and blue emission respectively (Figure 5). In the linear region, the response from red emission has highest intensity followed from the green emission and the blue emission showed the lowest response value, these results was expected since the PtOEP molecules

emit at 644 nm [16]. However the slope of all curves in this region nearly have the same values of 0.012, 0.013 and 0.013/DO(%) for red, green and blue emission respectively (Figure 5). At the low concentration region the derivative of curves responses (Figure 6) clearly showed the non-linear characteristic of sensor response since the derivative curves are non-constant in this region. These curves showed that as this region the response from the photodiodes array with red filter showed highest sensitivity followed by green filter and photodiodes array with blue filter showed least sensitivity at this region.

The Figure 7 depicts the dynamic response of optical fiber sensor; the transition process from water without DO to water with saturated DO has been so fast (8 s) however, the recovery process was slow (236 s). These results are different from the dynamic response for O₂ gas sensor reported in [17] where it was reported 2 s and 3.2 s for response and recovery time respectively even though, the active film was the same as used in the present work (PVC-PtOEP). The one and to order of magnitude larger of the response time and recovery time (relative to O₂ gas sensor) of the optical fiber sensor for DO detection is directly related to different diffusion process of O₂ in gas and water media. The diffusion process was shown slower in water media than in gas environment. For other side, the dynamic response (Figure 7) showed that the recovery process of sensor suffer a small hysteresis process that could be attributed to photobleaching degradation of PtOEP active molecules. As we know, there is only one paper that reported dynamic response for optical fiber sensor used for DO detection and this paper reported the 130 s for response time and 649 s for recovery process [13]. At all the results reported in this paper are significantly best.

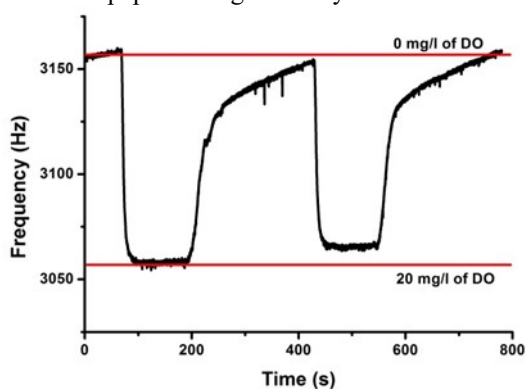

FIGURE. 7

THE DYNAMIC RESPONSE OF OPTICAL FIBER SENSOR USED FOR DO DETECTION.

CONCLUSIONS

The fluorescence based optical fiber sensor proposed in this work using the integrated circuit photodetector as fluorescence detector showed to have a successful performance for DO detection in water media. The integrated circuit photodetector with RGB filters showed to

be highly compatible with LED diode emission (used for PtOEP excitation) and fluorescence emission spectrum region since the RGB filter attenuated almost completely the light from the LED diode (377 nm) and allowed to pass the light originated from the fluorescence emission of the PtOEP molecules (644 nm). The dynamic response of sensor showed to have fast response time if we compared to previous reported values [13]. However, the sensor recovery process showed a small hysteresis process due to photobleaching effect that it is enhanced in water media so in order to obtain a reliable results it will be necessary to recalibrate the sensor after every measurement process. The fluorescence based optical fiber sensor together with diode LED excitation source and integrated photodetector with RGB filter could be integrated in one portable system as a depth gauge sensor for *in-situ* DO detection in any water environment like river, lake and fountains.

REFERENCES

- [1] Bhardwaj, J.; Gupta, K. K., "A Review of Emerging Trends on Water Quality Measurement" Sensors, 2015 International Conference on Technologies for Sustainable Development (ICTSD-2015), Feb. 04 – 06, 2015, Mumbai, India.
- [2] O'Neill, K.; Schreider, M.; McArthur, L.; Schreider, S., "Changes in the water quality characteristics during a macroalgal bloom in a coastal lagoon", Ocean & Coastal Management xxx (2015) 1-5 in Press.
- [3] Turner, E. L.; Paudel, B.; Montagna, P. A., "Baseline nutrient dynamics in shallow well mixed coastal lagoon with seasonal harmful algal blooms and hypoxia formation", Marine Pollution Bulletin xxx (2015) xxx-xxx, in Press.
- [4] Skoog, D. A.; West, D. M.; Holler, F. J. "Fundamentals of analytical chemistry" 5th edn. Saunders, Philadelphia, 1988, pp. 344.
- [5] Carpenter, J., "The accuracy of the Winkler method for dissolved oxygen analysis", Limnology and Oceanography, vol. 10, no. 1, Jan. 1965, pp. 135-140.
- [6] Misra, H. and Fridovich, I., "A convenient calibration of the Clark oxygen electrode", Analytical Biochemistry, vol. 70, No. 2, Jan. 1976 pp. 632-634.
- [7] Wolfbeis, O. S., "Fiber optic" Chemical sensors and biosensors, vol. 2. CRC Press, Boca Raton FL, 1991.
- [8] Mohr, G. J.; Wolfbeis, O. S. Anal. Chim. Acta 1995, 316, 239.
- [9] Vaughan, A. V.; Baron, M. G.; Narayanaswamy, R. Anal. Comm., Vol. 33, 1996, p. 393.
- [10] McMurray, H. N.; Douglas, P.; Busa, C.; Garley, M. S. J. Photochem. Photobiol. A: Chem. Vol. 80, 1994, p. 283.
- [11] Ramasamy, S. M.; Hurtubise, R. J., Anal. Chim. Acta, Vol. 152, 1983, p. 83.
- [12] Amai, Y. "Probes and Polymers for Optical Sensing of Oxygen", Microchim. Acta, Vol. 143, 2003, pp. 1-12.
- [13] Cheng-Shane Chu, Yu-Lung Lo, Optical fiber dissolved oxygen sensor based on Pt(II) complex and core-shell silica nanoparticles incorporated with sol-gel matrix, Sensors and Actuators B, Vol. 151, 2010, pp. 83-89.
- [14] Yang X.; Zheng Y.; Luo, S.; Liu, Y.; Yuan, L. "Microfluidic in-fiber oxygen sensor derivate from a capillary optical fiber with a ring-

shaped waveguide”, *Sensors and Actuators B*, Vol. 182, 2013, pp. 571–575.

- [15] Pulido, C.; Esteban, O. “Improved fluorescence signal with tapered polymer optical fibers under side-illumination”, *Sensors and Actuators B*, Vol. 146, 2010, pp. 190–194.
- [16] Braga, M. S.; Borges, V. F.; Gonçalves, G. M.; Gomes, O. F.; Salcedo, W. J. “Sensor óptico multifuncional para detecção de O₂ e oxigênio dissolvido”. *Proceedings of Safety, Health and Environment World Congress*, vol. 14, 2014, pp. 309-313.
- [17] Santos, D. S. and Salcedo, W. J., “Sistema de processamento de sinais e geração de imagens químicas para sensores LAPS, FMOS, TAOS baseados em dispositivos lógicos programáveis FPGA”, *Dissertação de mestrado, Escola Politécnica da Universidade de São Paulo*, 2014.